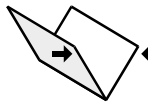

RIGHT and LEFT are relative to Professor Giraffenstein.

Mountain Fold 

Valley Fold 

1

Say the following prayer:

"Lord, help guide me to the successful completion of my new paper model project, and let it instruct me in a number of fun factoids relating to Your Creation. Amen."

2

Print out pages 1, 3, and 5 on card stock. Print page 2 on the back of page 1, and page 4 on the back of page 3 to color back of pieces.

3

Score folds, cut out internal white areas marked with an X, and cut out pieces.

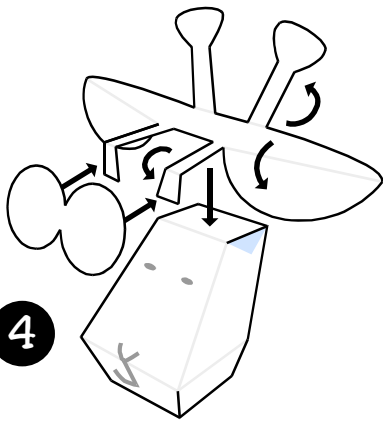
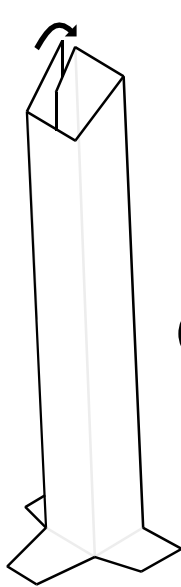

4 Assemble **NECK** and **HEAD**. Glue **SCALP** to gray area on top of head. Glue **GLASSES** to frame ends.

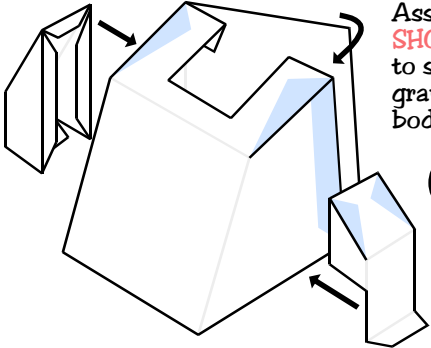

5 Assemble **BODY** and **SHOULDERS**. Glue sholders to sides of body in the gray areas, making sure body sits flat.

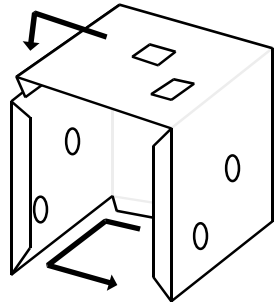

6

Assemble **MAIN BOX**, leaving the front and bottom panels off for now. fold and glue purple flaps in back as shown to strengthen box.

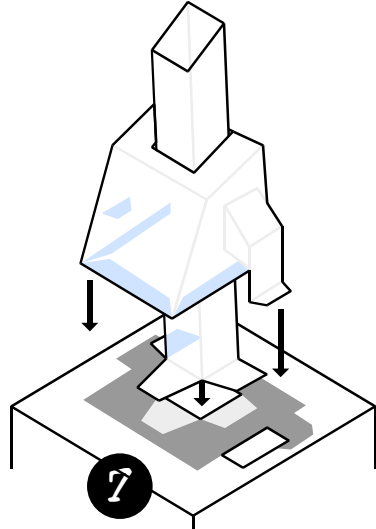
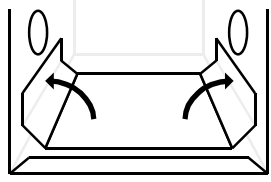

7

Glue neck to top of box. Slide body over neck and glue on dark green area of box, with all flaps folded inwards except the one on the left sholder.

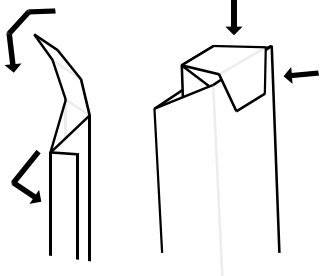

8

Assemble **NECK ROD**. Insert neck rod down neck with flat side facing forward and glue flap **A** to area **A** on top of neck. Glue head on top of area **H** on neck rod, making sure head is straight and centered along the back edge.

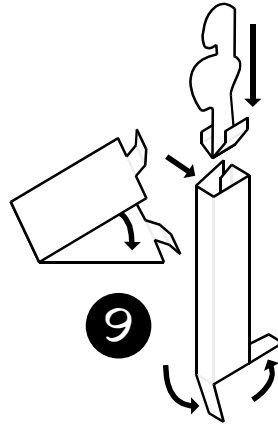

9

Assemble **ARM**. Fold **HAND** rectangle in half and glue halves together, leaving wrist flaps unglued. When dry, cut out hand shape. Fold up wrist flaps. Apply glue to outside flap ends and slide wrist into arm until flap ends are just below the top of the sleeve.

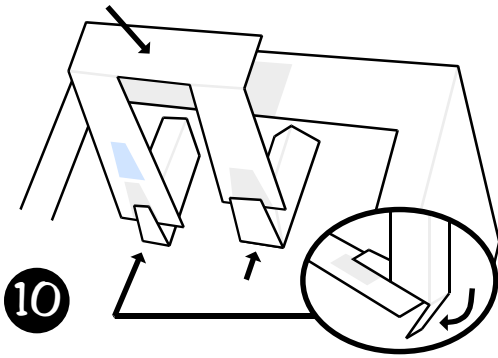

10 Glue **LEVER ARRAY** to dark green area on back of the box. Glue flap at end of neck rod to area **N** on short lever. Insert arm down hole under left sholder. Glue front arm flap to area **A** on long lever. Glue back arm flap to top of same lever so arm bottom is flat on lever.

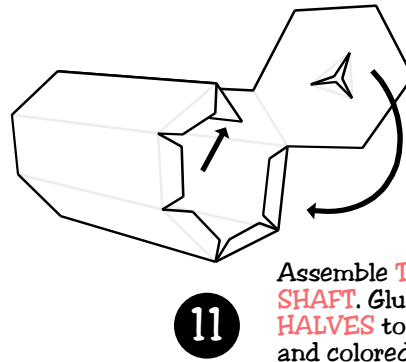

11 Assemble **TUMBLER** and **TUMBLER SHAFT**. Glue **TUMBLER GEAR HALVES** together so holes match up and colored sides face out. The inner flaps of the yellow half should fold through the hole in the purple half.

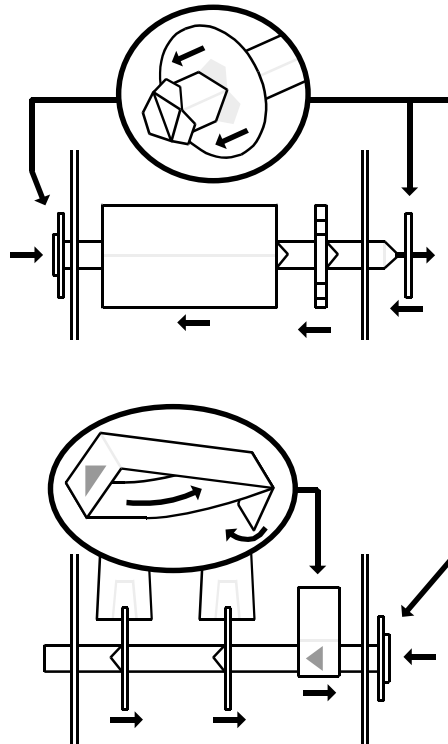
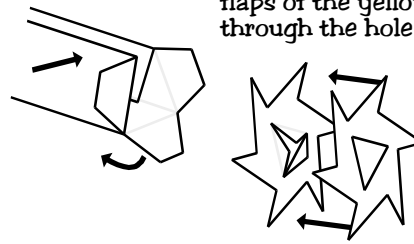

12 Glue **WASHER** to tumbler shaft's **L** end. Insert **R** end through box hole **TL**, then tumbler's **L** side, then yellow side of tumbler gear, and finally opposite box hole. Glue another **WASHER** to shaft's **R** end to secure it to box. Align and glue tumbler to dark red area of shaft and gear flaps to gray triangles.

13 Assemble **TUMBLER SWITCH** and **CAM SHAFT**. Glue **WASHER** to cam shaft **R** end. Insert other shaft end through box hole **CR**, then tumbler switch (with **arrow** pointing left,) then **HEAD CAM** and **ARM CAM** (red triangle sides facing left,) and finally opposite box hole. Glue tumbler switch to gray rectangles on shaft (one side of switch will curve a bit). Align and glue cams to gray triangles.

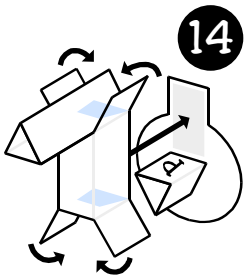

14 Assemble **CRANK SHAFT** and **CRANK HANDLE**. Place **CRANK WASHER** over left end of cam shaft, matching washer prong to side marked **P**. Glue gray side of crank shaft to crank washer prong and crank shaft end flaps to gray areas on cam shaft. Glue crank handle to crank shaft in a similar manner.

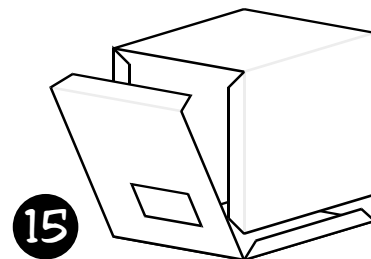

15 Glue on **FRONT AND BOTTOM PANELS**.

16 Turn the crank counter-clockwise and enjoy the educational fun of Creation Science Factoidamajimation!

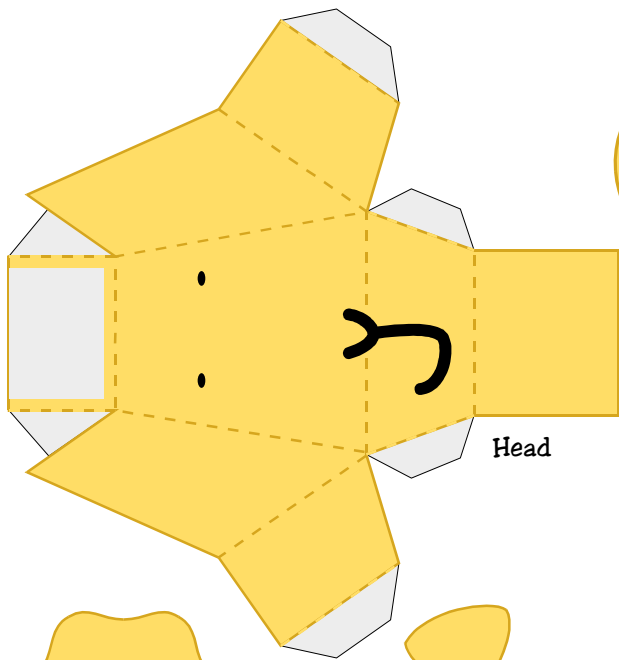
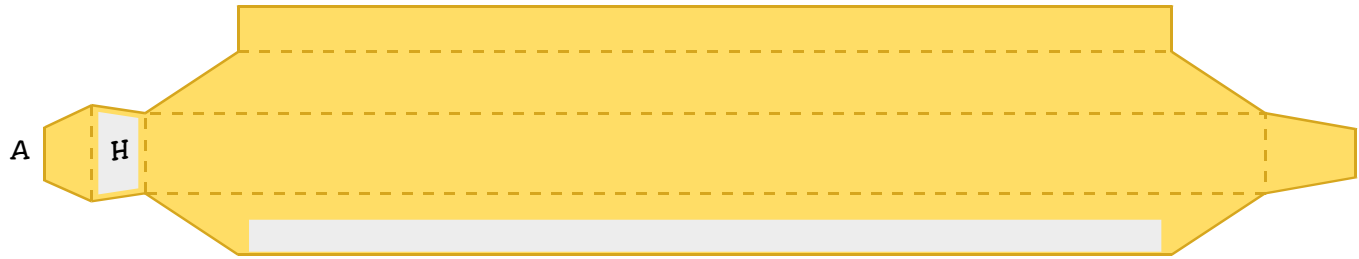

Neck Rod

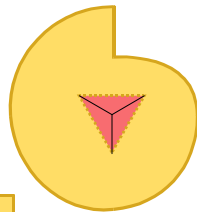

Arm Cam



Tumbler Switch

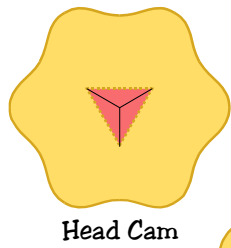
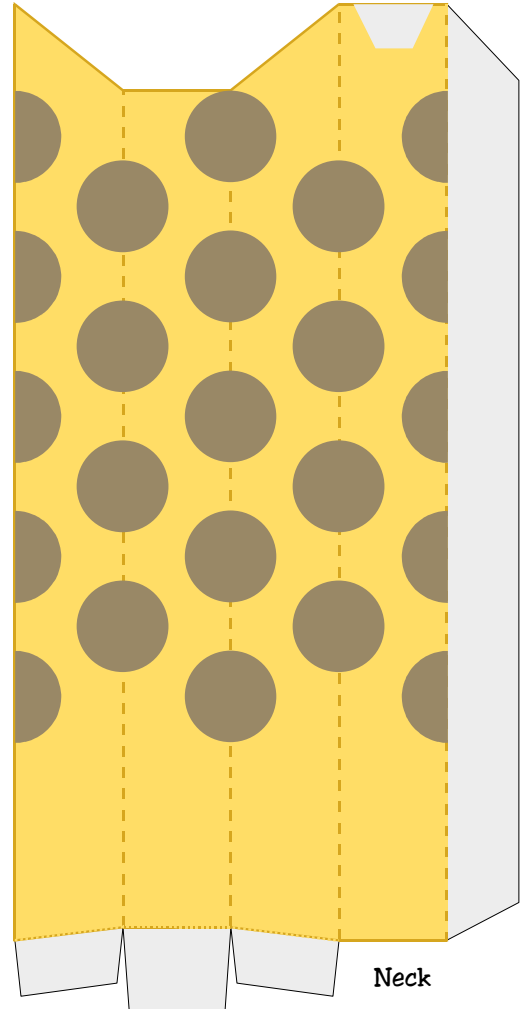

Head Cam

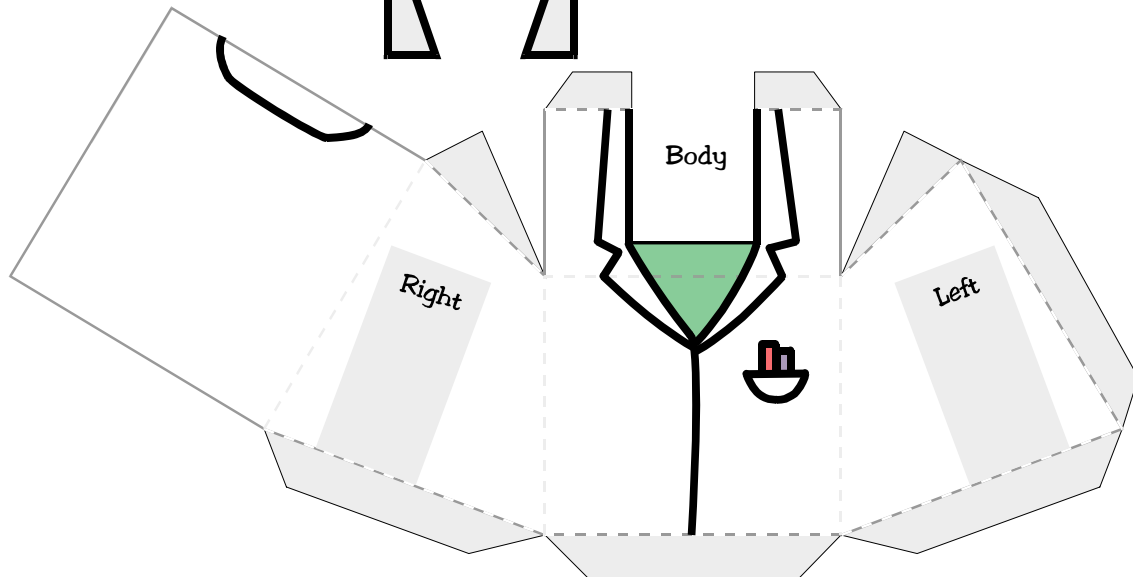
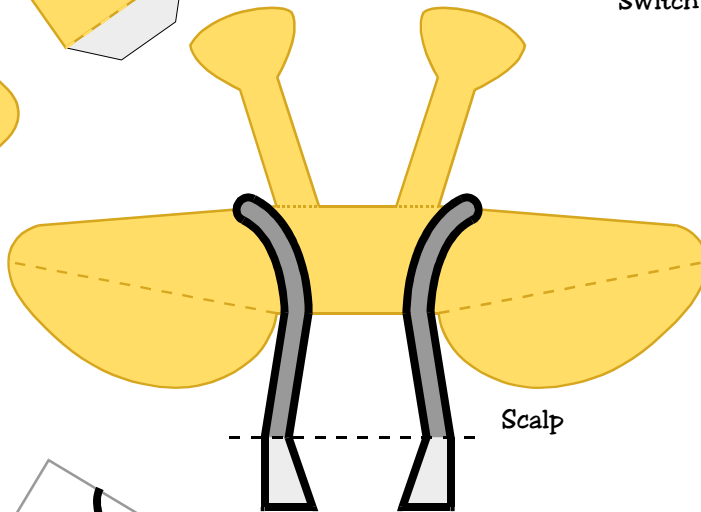



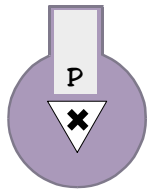

Crank Washer

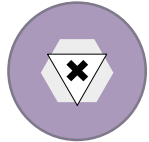

Washers

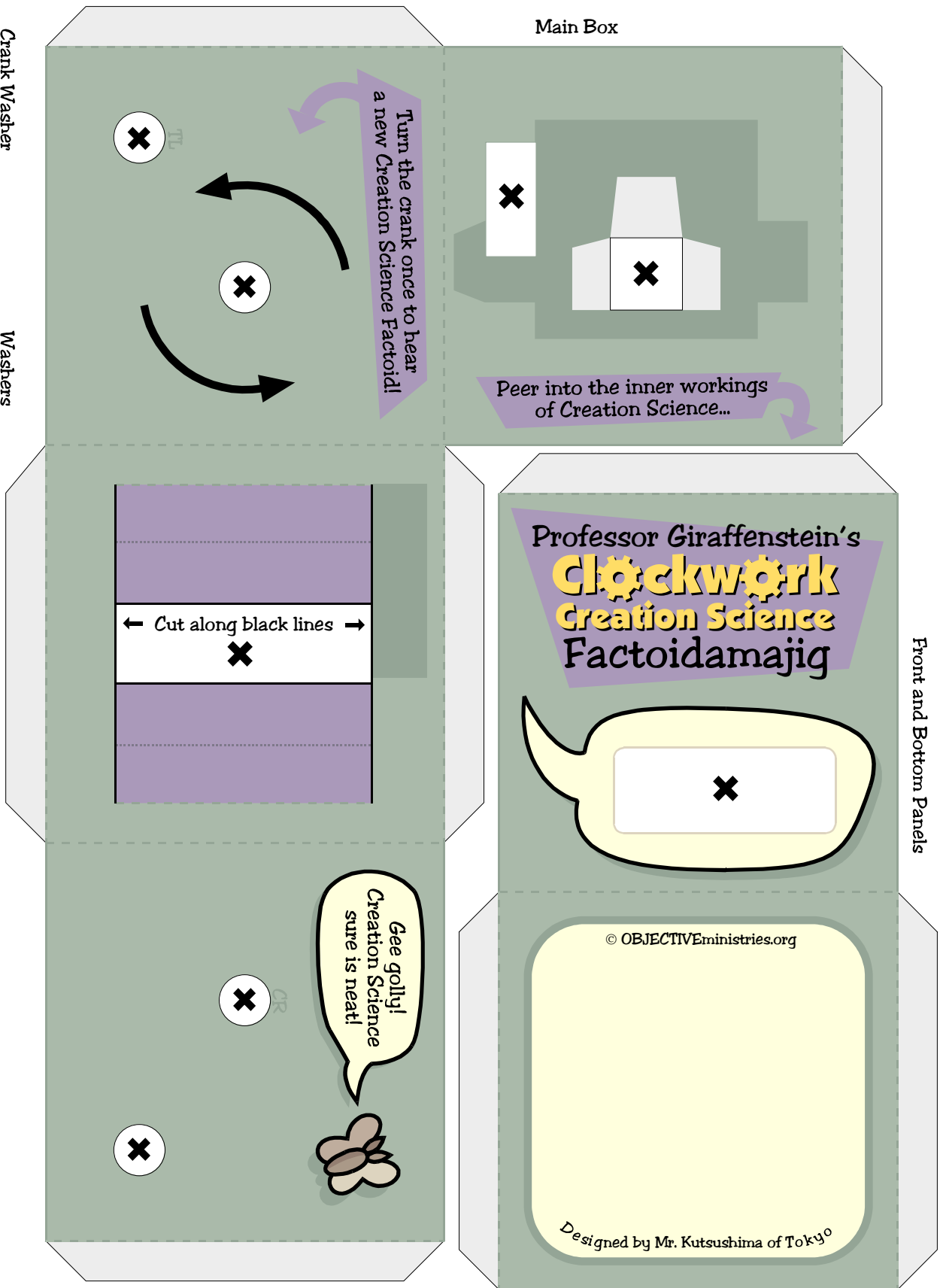
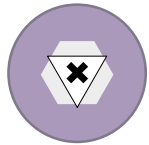

Main Box

Turn the crank once to hear a new Creation Science Factoid!

Peer into the inner workings of Creation Science...

Cut along black lines

Front and Bottom Panels

Gee golly!
Creation Science
sure is neat!

© OBJECTIVEministries.org

Designed by Mr. Kutsushima of Tokyo

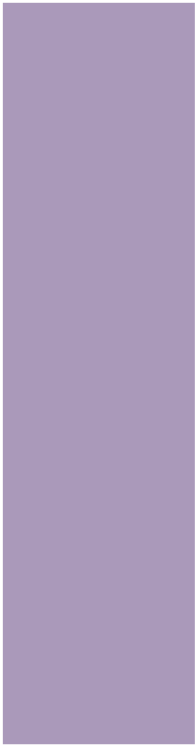

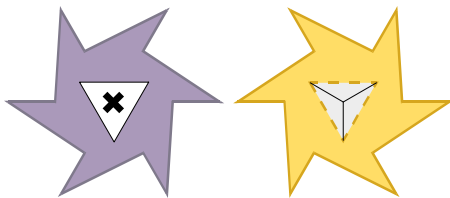
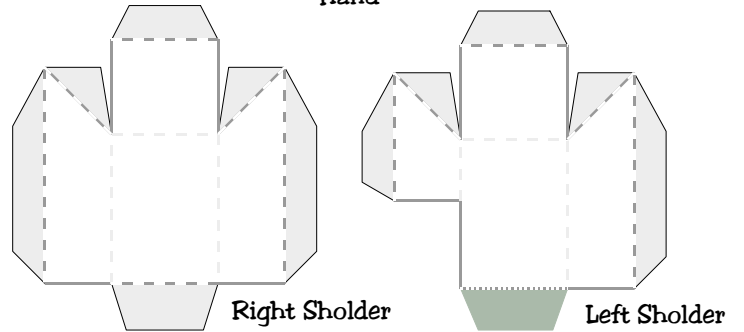
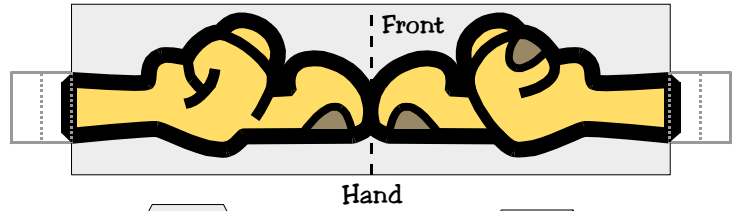
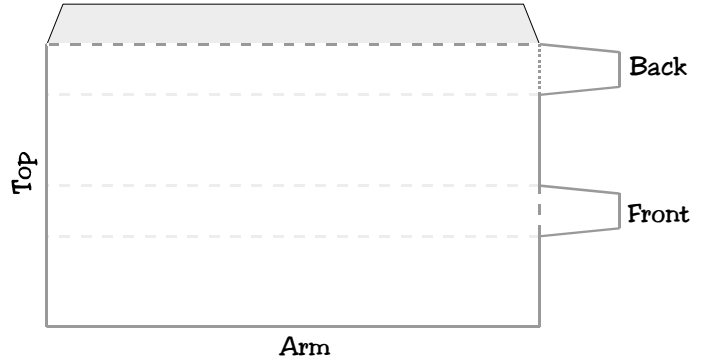

Tumbler Gear Halves

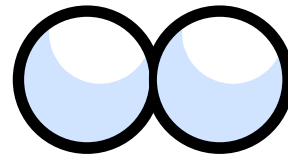

Glasses

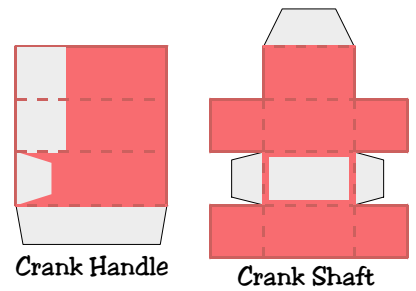
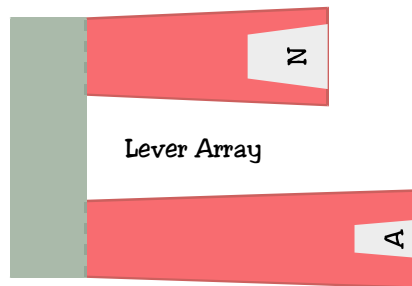

Tumbler Shaft

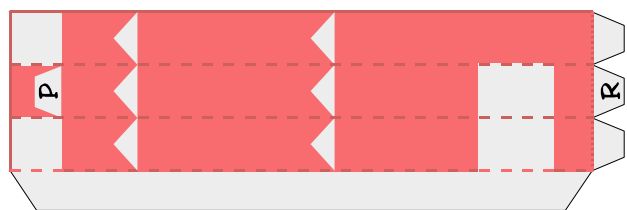

Cam Shaft